

TERMO DE GARANTIA DALLA COSTA

Os móveis Dalla Costa são elaborados dentro dos melhores padrões de qualidade obedecendo normas técnicas de fabricação. Garantimos este produto contra eventuais defeitos de fabricação por um período de 6 meses, contado a partir da data de venda, comprovado pela nota fiscal.

Constatado o defeito de fabricação o Sr(a) consumidor(a) deverá solicitar a assistência técnica através do estabelecimento da compra. Este termo de garantia será anulado e sem efeito na ocorrência de qualquer das seguintes hipóteses:

- O defeito apresentado for causado pelo proprietário ou por terceiros;
- Não forem cumpridas as recomendações de montagem contidas neste manual;
- O defeito apresentado for decorrente de desgaste natural do produto, agentes da natureza, transporte e armazenagem indevidos.

A matéria-prima usada é o MDF (medium Density Fibeboard), madeira ecologicamente correta proveniente de área de reforestamento, de alta resistência e durabilidade.

O acabamento de superfície dos móveis Dalla Costa é obtido com pintura e secagem ultravioleta.

Para Conservar a qualidade e a beleza do móvel recomenda-se os seguintes cuidados:

- Evite colocar em local excessivamente úmido;
- Evite a incidência direta de luz solar;
- Evite colocar objetos pontiagudos diretamente em cima do móvel.

Para limpeza recomenda-se somente pano umedecido em água.

DALLA COSTA WARRANTY TERMS

Dalla Costa furniture is produced within the best quality criteria following technical manufacturing standards. We guarantee this product against eventual defects for a period of 6 months, starting from the sale date stated on the purchase receipt. Manufacturing defect found Mr (a) consumer (a) shall seek technical assistance through the establishment of purchase.

This warranty term will be canceled and disregarded if any of the situations below occurs:

- The defect was caused by the owner of the goods or by a third part;
- The assembly recommendation contained in the assembly instructions is not followed appropriately;
- The defect is due to natural wear of the product, nature factors or improper transport or storage ;
- The used raw material is MDF (Medium Density Fibeboard), wood within ecologically acceptable standards from a reforestation area, with high resistance and durability.

The surface finish of Dalla Costa furniture is obtained with paint and ultraviolet drying.

To keep the quality and beauty of your furniture we recommended the following care to be taken:

- Avoid putting it in places extremely wet;
- Avoid exposing in to direct sun light;
- Avoid placing sharp objects directly on the piece of furniture. It is recommended that a damp piece of cloth is used for cleaning it.

TÉRMINO DE GARANTIA DALLA COSTA

Los muebles Dalla Costa son concebidos dentro de los mejores padrones de excelencia obedeciendo las reglas práctica del conocimiento de fabricación. Asegurémonos este producto contra eventuales defectos de fabricación por una temporada de seis meses, referiéndose de la fecha de venta probada en la factura. Defecto de fabricación encontrado el señor (a) consumidor (a) se solicite asistencia técnica a través del establecimiento de compra.

Este término de garantía será cancelado, si se hubiera descubierto cualquier de las siguientes circunstancias:

- Defecto presentado fue motivo de no haber tenido cuidado;
- No cumplir las recomendaciones de montajes según el plan;
- Si el defecto presentado fuera transcurriente de la vida util del mismo, agente de la naturaleza, transporte y almacenaje inadecuado;

- La materia prima utilizada en los muebles es el MDF (Medium Density Fibeboard), madera ecológica correcta originaria de la área del repoblación, de muchísima durabilidad y soportabilidad.

El acabado de superficie de los muebles de Dalla Costa son obtenidos con la pintura y secado ultravioleta.

Para la conservación de la cualidad y hermosura del mueble segue abajo las siguientes recomendaciones:

- Evita dejarlo en un sitio excessivamente húmedo;
- Evita influencia directa de luz solar;
- Evita poner objetos afilado con punta directamente encima del mueble.

Para limpeza es recomendable solo un panõ humedecido en agua.

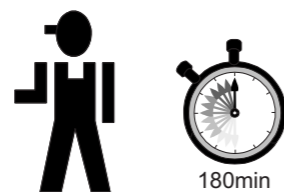
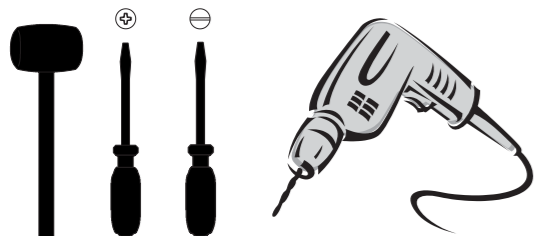

M Ó V E I S
DALLA COSTA

Móveis Dalla Costa Ltda | Rua Arlindo Franklin Barbosa, 3250
Bairro Pradial | Fone (55) 54 3455-4900 | Cep 95708-200
Bento Gonçalves | Rio Grande do Sul | Brasil
dallacosta@dallacosta.com.br | www.dallacosta.com.br
facebook.com/moveisdallacosta







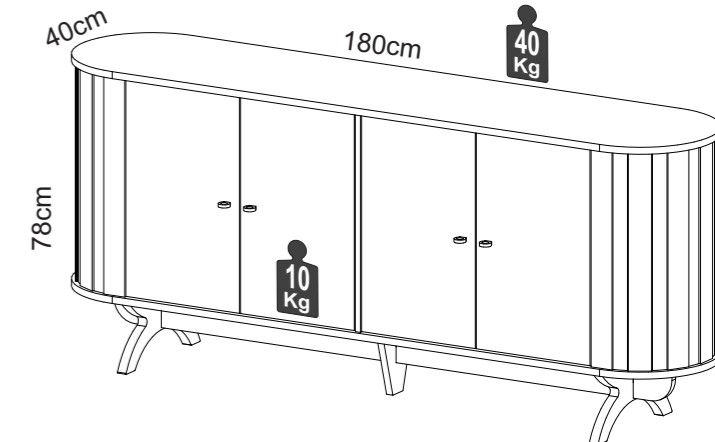
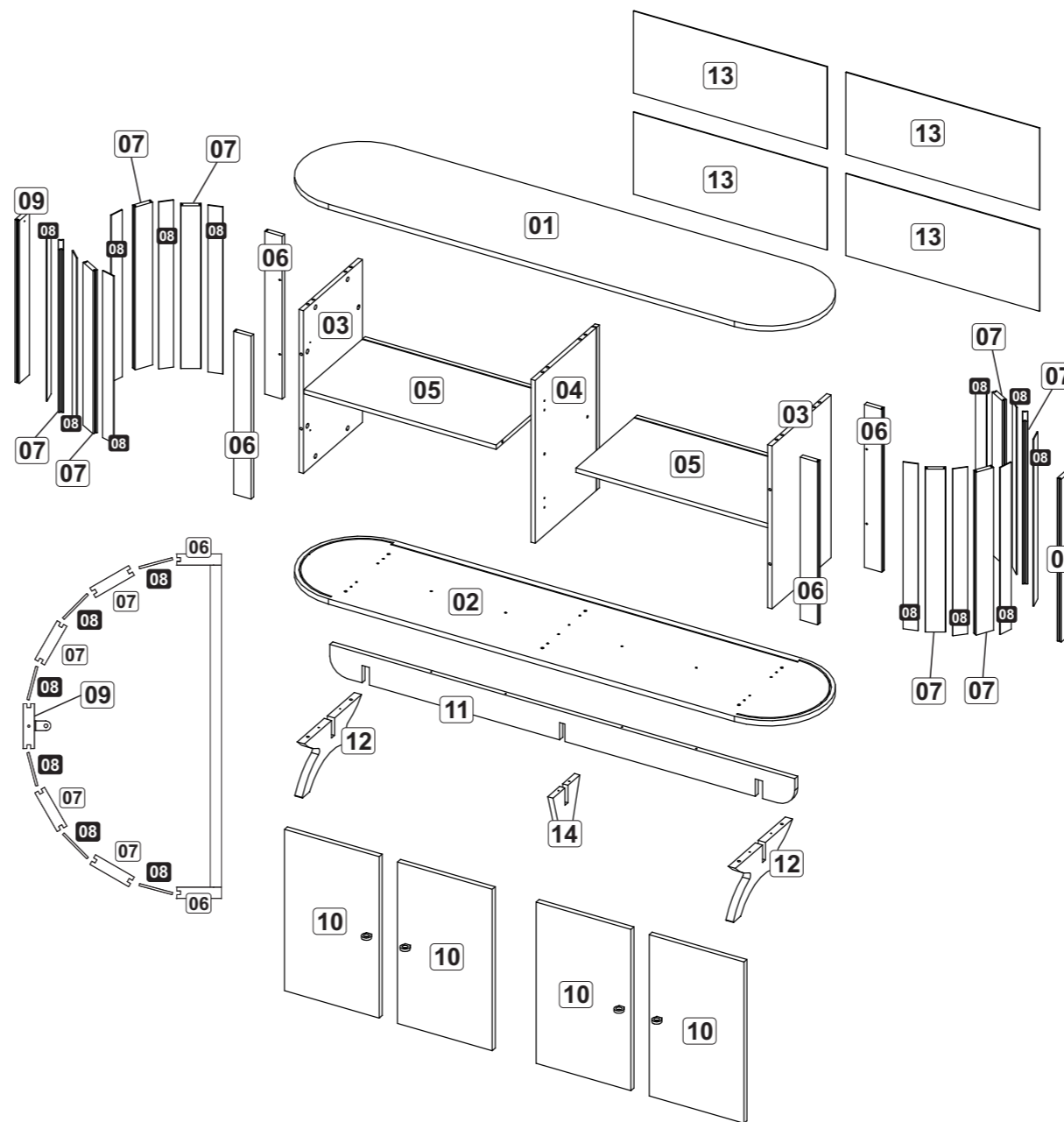

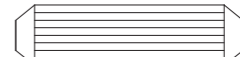

**Recomendamos
que este produto
seja montado por um
técnico qualificado**

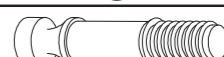
INSTRUÇÕES DE MONTAGEM

TB296

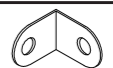

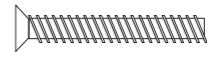
FERRAGENS / HARDWARE / MATERIALES

A		8 x 30	24
B			18
C			18
D		4,0 x 14	36
E		M4 x 20	04
F		4,0 x 50	14
G		Dobradiça Super Curva	08
H			02
I			04
J		Ø19mm	18
K		M4 x 25	04
L		M4	04

Lista de peças

Denominação

- 1 - Tampo
- 2 - Base
- 3 - Lateral
- 4 - Divisão
- 5 - Prateleira
- 6 - Moldura Frontal
- 7 - Moldura
- 8 - Friso
- 9 - Moldura Lateral
- 10 - Porta
- 11 - Travessa
- 12 - Pé
- 13 - Costa
- 14 - Pé Central

Parts list

Description

- 1 - Top
- 2 - Base
- 3 - Side
- 4 - Division
- 5 - Shelf
- 6 - Front Frame
- 7 - Frame
- 8 - Frieze
- 9 - Side Frame
- 10 - Door
- 11 - Crossbar
- 12 - Feet
- 13 - Back
- 14 - Center Feet

Lista de piezas

Denominación

- 1 - Tapa
- 2 - Base
- 3 - Lateral
- 4 - División
- 5 - Estanteria
- 6 - Adorno Frontal
- 7 - Adorno
- 8 - Friso
- 9 - Adorno Lateral
- 10 - Puerta
- 11 - Travesaño
- 12 - Pie
- 13 - Revés
- 14 - Pie Central

01 - Pré Montagem

